

reltec

Electron Supplementation Device HD21

INSTRUCTION MANUAL

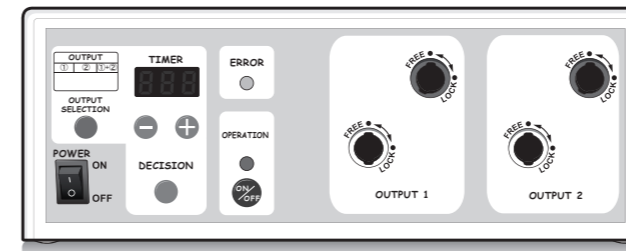

Table of Contents

Introduction

- 1. For proper use 2
- 2. Configuration 6
- 3. Name and function of each main body part 7

Before use

- 1. How to connect plates 8
- 2. How to wrap with spiral tubes 9
- 3. How to fit a cover to a plate 9
- 4. How to use velcro 9
- 5. How to connect power cord and AC adapter ... 10
- 6. Method of use 11

How to apply

- 1. How to apply (Type BD) 12
- 2. How to apply (Type YD) 14

How to use

- How to operate 16

ENERGY CHECK

- 1. Intended use 21
- 2. How to use ENERGY CHECK 21
- 3. Pay attention to the following instructions 22

Troubleshooting

23

Specifications

24

Other information

- How to store the device 24
- How to dispose of or transfer the device 24
- Replacement of consumables 25
- Maintenance list 25

About the Warranty

The warranty card (3rd copy) is a copy for the customer. Please keep it in a safe place, as well as the instruction manual.

Purpose of use of your personal information

Please note that a copy of the warranty card filled out by the customer may be used for service activities during the warranty period and for subsequent safety inspection activities.

Please fill out the following information for easy reference.
Check the product name and serial number before contacting your dealer to place an order or ask for inspection, repair, etc.

Serial Number	Date of Purchase	Dealer
		TEL () —

Manufacturer
RELTEC Medical Devices Corporation

3795-1, Kawatsu-cho, Sakaide-shi, Kagawa, 762-0025, Japan

<https://reltec.co.jp>

Please read before use

Thank you for purchasing HD21.
Be sure to read this instruction manual carefully before use and use this device appropriately.
Keep this manual at hand for quick reference at any time necessary.

Introduction

1. For proper use

Thank you for purchasing Electron Supplementation Device HD21.

Electron Supplementation Device HD21 is a health-related device and is not a medical device.

This device is intended for use only for general wellbeing purposes or to encourage or maintain a healthy lifestyle, and is not intended to be used for any medical purpose (such as the detection, diagnosis, monitoring, management or treatment of any medical condition or disease).

Please consult a physician for any medical advice required.

This device is for domestic use only and must not be used outside of the country for safety and legal reasons.

Be sure to read this manual carefully before use and use this device appropriately.

The following signs indicate the possibility of causing harm or physical damage to users and other persons when the device is handled incorrectly disregarding the signs.

 **Warning** This sign indicates the possibility of causing "death or serious injury" when the device is handled incorrectly disregarding the sign.

 **Caution** This sign indicates the possibility of causing "injury or physical damage" when the device is handled incorrectly disregarding the sign.



Explanation of display marks

 **Prohibitions** This sign indicates prohibited actions.

 **Compulsory** This sign indicates mandatory actions.

 Do not disassemble  Operator's manual

 Keep fire away  Dangerous voltage

 Prohibited from use in water areas  Alternating Current

 Unplug the power cord from the outlet

Warning

 Do not use the device in combination with any of the following electronic medical devices since it may result in malfunction.

- Life-support devices such as an artificial heart-lung machine.
- Wearable electronic medical devices such as an electrocardiograph.

Do not use if you have been diagnosed with heart disease and are restricted from daily extreme exercise.

Caution

 **Any of the following persons who are judged to be inappropriate to use the device by a doctor must not use.**

1. Person with malignant tumor.
2. Person with heart diseases. (Person with heart problems)
3. Pregnant woman (Especially person in the early stage of her pregnancy, or immediately after childbirth.)
4. Person with sensory disturbance due to advanced peripheral circulatory disorders caused by diabetes, etc.
5. Person with high fever
Person with his body temperature of 38 °C or above (incidence of fever). (Person suffering from symptoms of severe acute inflammation) (fatigue, chill, blood pressure fluctuation, etc.) (and person who is debilitated.)
6. Person who requires bed rest.
7. Person with acute (painful) diseases such as spinal fracture, sprain and muscle strain.

When used by children, the device must be used under the supervision of a parent or guardian. Do not allow children to play with or climb on the device itself or the plate.

 **Keep flammable materials and cigarettes away from the device.**
Keep the main body and accessories away from heaters.
Failure to do so may cause a fire or a fault.

 **Never open the case as high voltage is generated inside of the main body.**
Do not disassemble, repair, or modify the main body and accessories.

 **Do not use this device in very humid and moist places such as in a bathroom.**
Failure to do so may cause injury such as electric shock or a fault.
Do not wash the main body and accessories in water.

 **When you notice any abnormalities such as unusual odor, abnormal sound, smoke, etc., switch off the device, unplug the power cord from the outlet and discontinue use.**
When the device is dropped, pushed down, or subjected to a strong shock switch off the device immediately, unplug the power cord from the outlet and discontinue use.

If liquid enters the main body or accessories, switch off the device immediately unplug the power cord from the outlet and discontinue use.

※ Contact your dealer if you have any of the problems mentioned above.

While lightning is occurring, stop using the device and unplug the power cord from the outlet.

Caution



Do not place anything on top of the device.

Keep the device away from other electrical appliances.

Do not use the device in combination with a mattress made of conductive substances such as metallic fibers.

Do not insert a metal rod, etc. into the sockets for plates.

Be careful not to apply excessive force to the plate cables, power cord and AC adapter.

The cables must not be excessively bent, pulled, twisted, or rolled up into a small bundle. In addition, do not place heavy objects on the cables.

Failure to do so may shorten the life of the cables and cause a fire, electric shock, or an accident.

Do not apply shock to the plugs as they may be damaged.

Do not use accessories other than those (power cord, AC adapter, plate AC, BD or YD) provided by us.

Do not use the main unit and accessories for other purposes.

Do not touch with wet hands.

Failure to do so may cause injury or malfunction such as electric shock.

Precautions before use

Caution



Please read the instruction manual before using the product for the first time.

Power cord, AC adapter, and plates must be connected correctly and securely.

Make sure switches, buttons, and timers are working properly.

When using device that has not been used for some time, make sure that the device is in good and safe working order.

Connect the plate and check that the switches, buttons, and timers are working properly.

Make sure to apply the plates to the body before starting operation.

If you apply the plates after starting operation, the plates may be damaged and you may feel an unpleasant electric stimulation similar to static shock.

Stop operating the device firstly in case of removing the plates from applied parts.

When applied part of the plates are wet with sweat or covered with ointment, make sure to wipe it off before use.

When a plate is wet or damp with sweat, dry it completely before use.

Never attempt to dry it using a hair dryer or heater as it may result in damage.

If any of the plates are damaged or in a fault condition, discontinue use immediately.

Consult your dealer or our company as it is dangerous to make a repair by yourself or use the device continuously.

Caution



Do not use with other electrical appliances.

Do not install or use the product in the following locations.

- Do not put the device on an inclined surface or in an unstable location where it is subjected to shock or frequent vibrations.
- Do not place the device in a hot place where there is a heater nearby or where it is exposed to direct sunlight.
- Do not put the device in a place where dust, salt, sulfur etc. may cause adverse effects.

Keep the main body and accessories away from a container of liquid such as a vase or an aquarium.

If liquid enters the device, it may cause a fire or a breakdown.

When you apply the plates to the body, be careful not to bend them too sharply by tightening them excessively.

The plates may be damaged if bent too much.

Cautions during use

Caution



When you feel any abnormalities in your body, stop using the device immediately.

People around you should not touch the person who is using the product. Also, while using the product, do not touch people or things around you.

In the event of a blackout, switch off the device immediately.

Always stop operation before using it on another part of the body or on another person while it is in use.



Do not allow metal objects (bed, chair, precious metal, etc.) to come in contact with the body and plates during use.

Do not use for more than 60 minutes at a time.

Have at least one hour between the end of the last use and the start of the next use.

Cautions after use

Caution



Please turn off the power switch on the front of the unit after use.

Before moving the unit, remove the AC adapter, power cord and the plates from the unit. In addition, hold the unit with both hands to prevent it from falling down.

If you accidentally drop the unit, be sure to contact the dealer where you purchased it for inspection.

Otherwise, even if the appearance and operation are normal, there may be malfunctions and accidents in the future.

2. Configuration

※Please check that all the components listed below are provided by placing a check mark in each box.



Main body (1unit)



Instruction manual (1copy)



保証書 (1部)

Timer screen

It displays the configured operating time. The buzzer volume appears only when the end tone and operation tone volume are set. (See Page 16.) When an error occurs, the error code also appears here. (See Page 20.)

Output position LED

Output position selected via the output selection button LED on
 ex) Output 1

Output selection button

Select the output position.

Main power switch

indicates "OFF", and indicates "ON".

3. Name and function of each main body part

"+" "-" button

Press the button, then you can set the operating time, the ending sound volume and the operation volume. (See page 16. ~ 17.)

Error (LED flashes: pink)

When the plate is not properly inserted, the pink LED flashes and the buzzer makes sound.

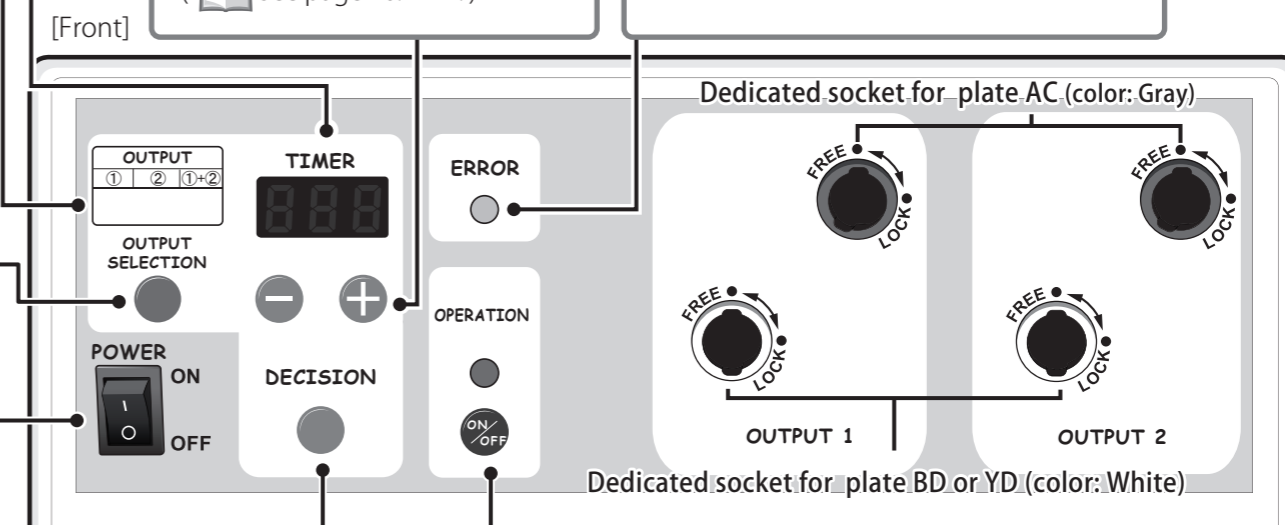

Decision button

You can store in memory the operating time set by the "+" and "-" buttons, the ending tone and operation tone volume, and the output poles selected by the output selection button. (See page 16. ~ 17.)

Operation button

"ON/OFF" state. The LED is on during operation.

Rating label

Information such as serial number is written.

[Back]



Accessories [Not covered by warranty]

※1 Do not remove the ferrite core.



Power cord (1 pc)



A C adapter (1 pc)



ENERGY CHECK (1 pc)

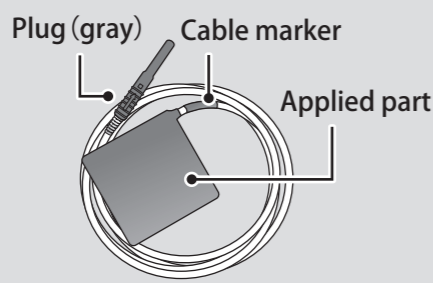

Plate AC (2 pcs) (Cable marker : red, blue)

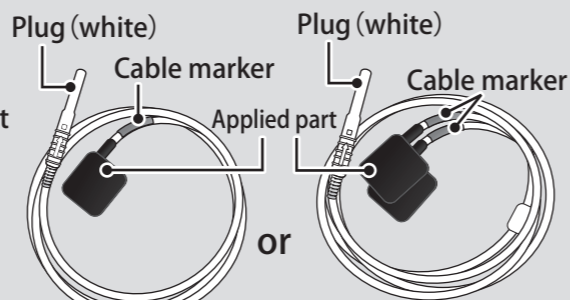

Plate BD or YD (2 pcs) (Cable marker : red, blue)



Spiral tube [Plate..... 4m type: 16pcs 2.5m type: 10pcs]



Velcro [L 1 pc (Length: 120cm) M 1 pc (Length: 80cm) XS (Length: 30cm) Plate BD... 2 pcs Plate YD... 4 pcs]



Cover (S) (4pcs)

Cover (XS)

[TypeBD: 4pcs TypeYD: 8pcs]

※All of the accessories in the box are consumables and are not covered by warranty.

1. How to connect the plate AC and BD or YD

Please make sure to insert the plugs to the main unit, holding down the main unit so that it will not slip out of place.

Plate BD or YD (color: White)

Hold the plate BD or YD plug (white) with the arrow ↑ facing up and insert it all the way into the socket (white) straight and firmly. Then turn the plug 90 degrees to the right.

(The plate BD or YD can be inserted with the arrow ↑ facing downward.)

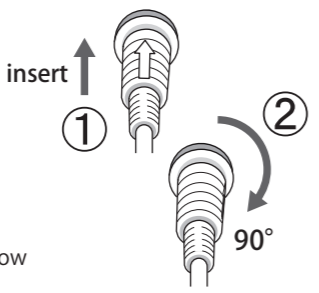
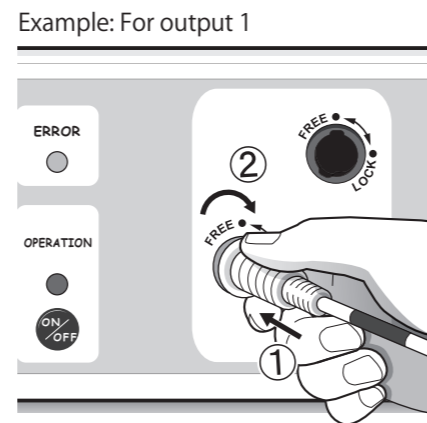
[Diagram of inserted state]

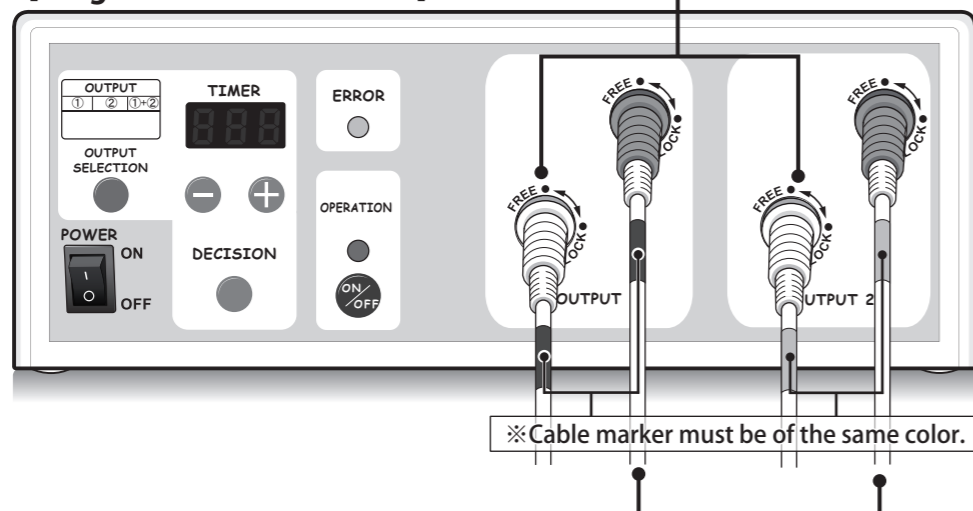
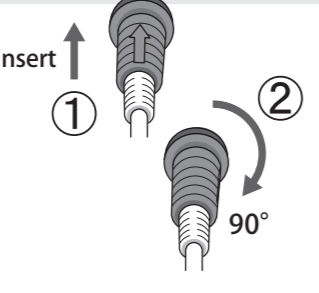
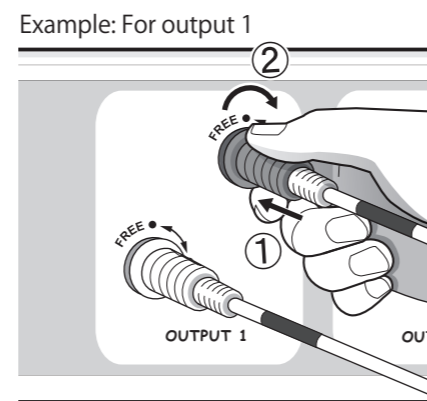

Plate AC (color: Gray)

Hold the plate AC plug (Gray) with the arrow ↑ facing up and insert it all the way into the socket (Gray) straight and firmly. Then turn the plug 90 degrees to the right.





⚠ Caution

- Make sure to turn the plug 90 degrees to the right. Otherwise, the plug cannot be firmly fixed and it may fall from the socket.
- Please match the colors of the plug and socket when you insert. Inserting the plug into incorrect socket may result in damage or inability to pull out the plug.

2. How to wrap with spiral tubes

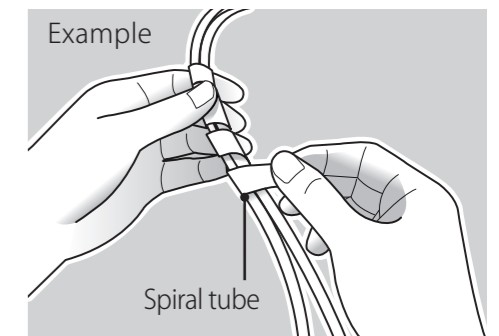
Wrap the plate cables with the provided spiral tubes in spots.



In case of YD plate 4m

Spiral tube : 8pcs

Example

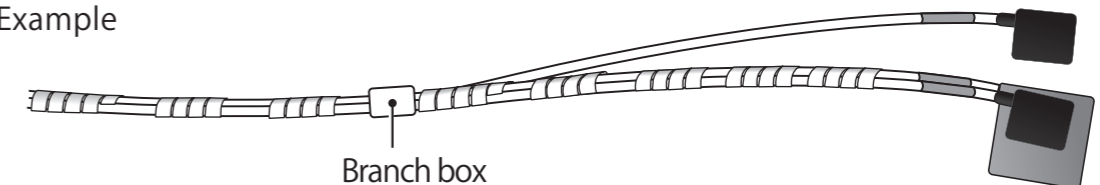

3. How to fit a cover to a plate

Fit a provided cover to a plate. Open the hook and loop closure on one side of the cover and insert the plate in it. Then close the hook and loop closure.

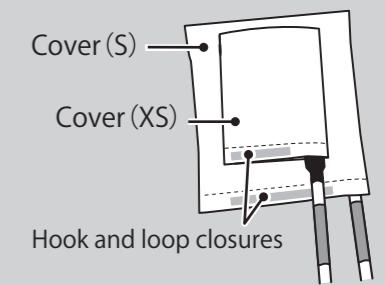

4. How to use velcro

Have a provided velcro at hand for applying the plates to the body. The velcro is available in different lengths (L, M and XS). They have hook and loop closures for flexibility and fixation that make the plates easier to be put on the body.

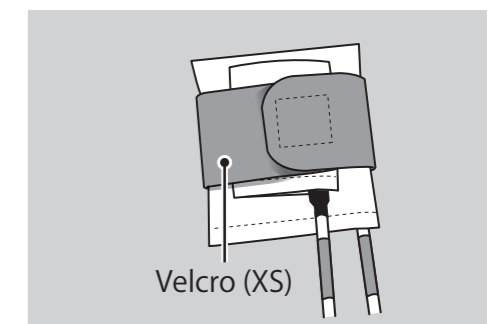

5. How to connect power cord and AC adapter

To prevent the power cord outlet from falling off, the outlet is made harder.

Connect the power cord's connector to the AC adapter's socket, and insert the AC adapter's plug into the AC adapter socket of the main unit.

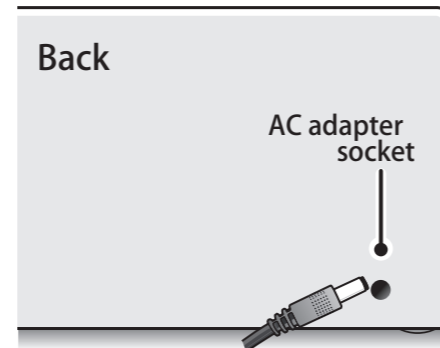
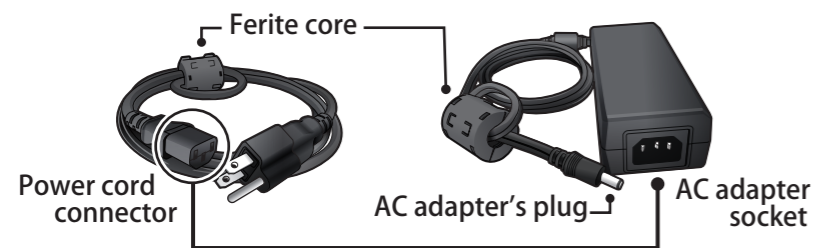

Prohibitions

Make sure not to remove the ferrite core being equipped power cord and AC adapter.
Failure to do so may result in having a negative impact on the other machines.
Our company shall not be liable for any damage resulting from misuse such as removing the ferrite core.



Caution

Make sure to use the power cord only equipped with protective earth to avoid the dangerous of electric shock.

6. Method of use

Typical use case

Period	Single use time	
Day 1 - Day 3	5 to 10 min	If you feel temporary body sluggishness, shorten the duration of each use.
Day 4 - Day 7	10 to 15 min	
Day 8 ~	15 to 60 min	

Use per day
1 to 5 times
(standard)

Single use time
5 to 60 min
(standard)

- ① The above table is an example of standard use.
Please adjust the duration of use and the number of times per day according to your physical condition.
- ② Allow at least one hour after each use before the next use.
- ③ When using the product for the first time, use it for a short time (5 to 10 minutes) and gradually acclimate your body to it through repeated use.
- ④ If you feel temporary weakness, shorten the duration of each use or reduce the number of times you use it in a day.
- ⑤ Depending on the age, physical strength, and weight of the user, such as children and the frail, adjust the duration of use appropriately, such as 20 minutes or less per use.
- ⑥ If you feel any physical abnormality, discontinue use immediately.
- ⑦ Stop the operation before using the conductor for another person.
- ⑧ Recommend using the front and back plates alternately.
- ⑨ If you have not used the conductor for a month or more, use it for a short period of time (5 to 10 minutes) and gradually acclimate yourself to it through repeated use.

How to apply (Type BD)

Before starting operation, appropriately apply plates AC and BD to the body using the provided velcro.

1. Typical application (Hands)

OUTPUT 1 + 2

Apply the plates AC to the back of the hands, BD to the palms.

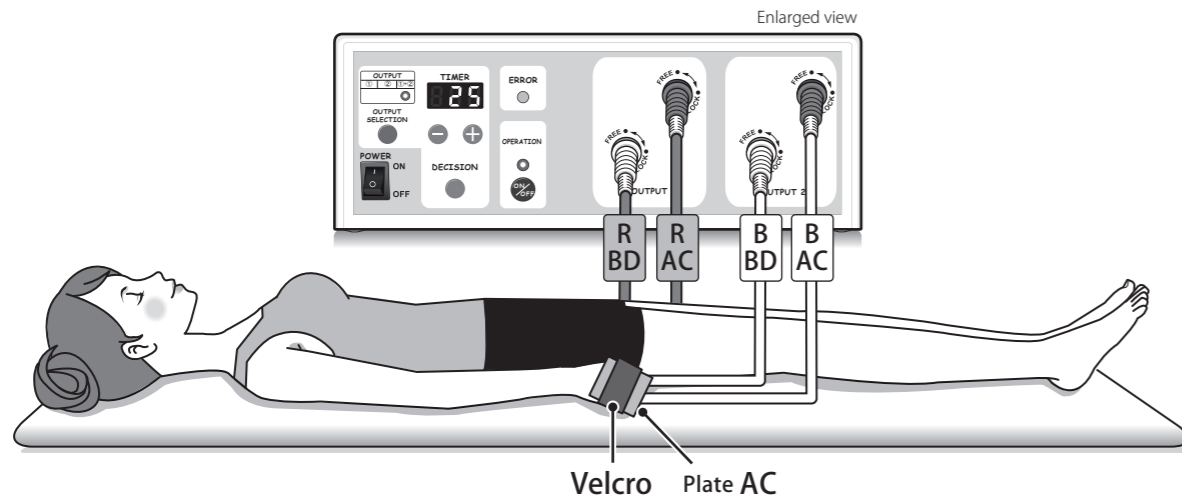

2. How to use monopole (Hand)

OUTPUT 1 or OUTPUT 2

Apply the plate AC to the back of one hand, BD to the palm.

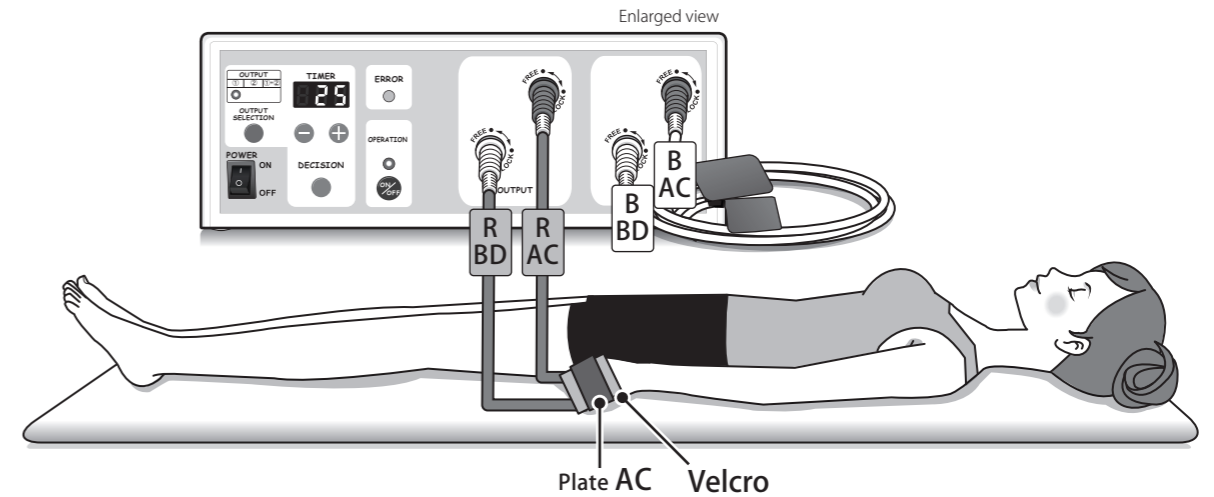

How to apply to hand

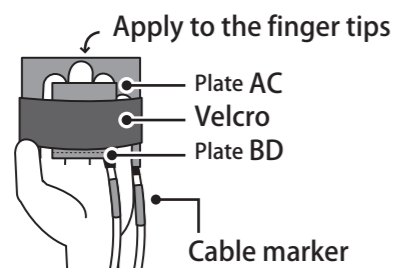

Apply the plates AC and BD so as not to come in contact with each other. The plate AC can be applied to the palm, and BD to the back of the hand.

Red, Blue cable marker

A set of the plates with Red or Blue cable markers can be inserted into the sockets either on the right or left side. Make sure that the cable markers of the plates AC and BD for each set are of the same color.

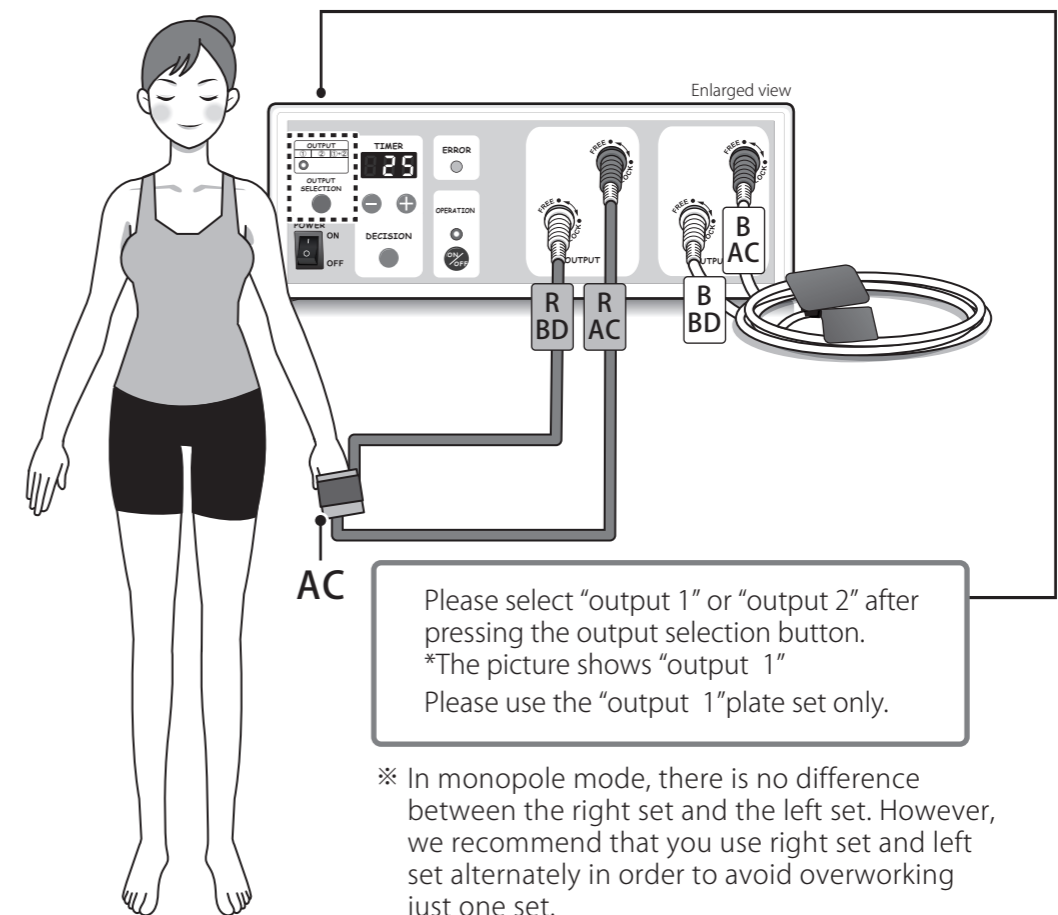
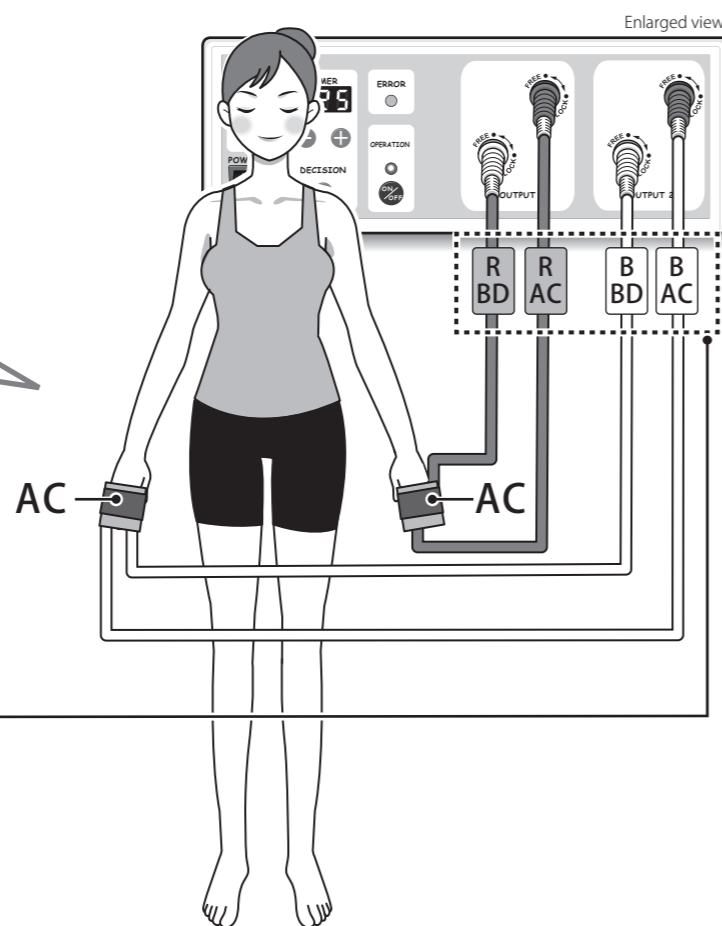

Please select "output 1" or "output 2" after pressing the output selection button.
*The picture shows "output 1"
Please use the "output 1" plate set only.

※ In monopole mode, there is no difference between the right set and the left set. However, we recommend that you use right set and left set alternately in order to avoid overworking just one set.

The plate AC can be applied to the palm and BD to the back of the hand.

- Be sure to lie down while using the device.
- The plates can be applied to either the right or left hand, however, make sure the cable markers of the plates applied to the hand and foot on each side must be of the same color.

Please make sure to have at least an hour between the end of the last session and the start of the next session.

R AC → Red cable marker AC B AC → Blue cable marker AC
R BD → Red cable marker BD B BD → Blue cable marker BD

The pictures above are for illustrative purposes and the shapes, color, etc. may be different from the real ones.

The plate AC can be applied to the palm and BD to the back of the hand.

- Be sure to lie down while using the device.
- The plates can be applied to either the right or left hand, however, make sure the cable markers of the plates applied to the hand and foot on each side must be of the same color.

Please make sure to have at least an hour between the end of the last session and the start of the next session.

R AC → Red cable marker AC B AC → Blue cable marker AC
R BD → Red cable marker BD B BD → Blue cable marker BD

The pictures above are for illustrative purposes and the shapes, color, etc. may be different from the real ones.

How to apply (Type YD)

Before starting operation, appropriately apply plates AC and YD to the body using the provided velcro.

1. Hands and feet

OUTPUT 1 + 2

The plates AC on the dorsum of the hand, YD on the palm, and YD on the soles of both feet.

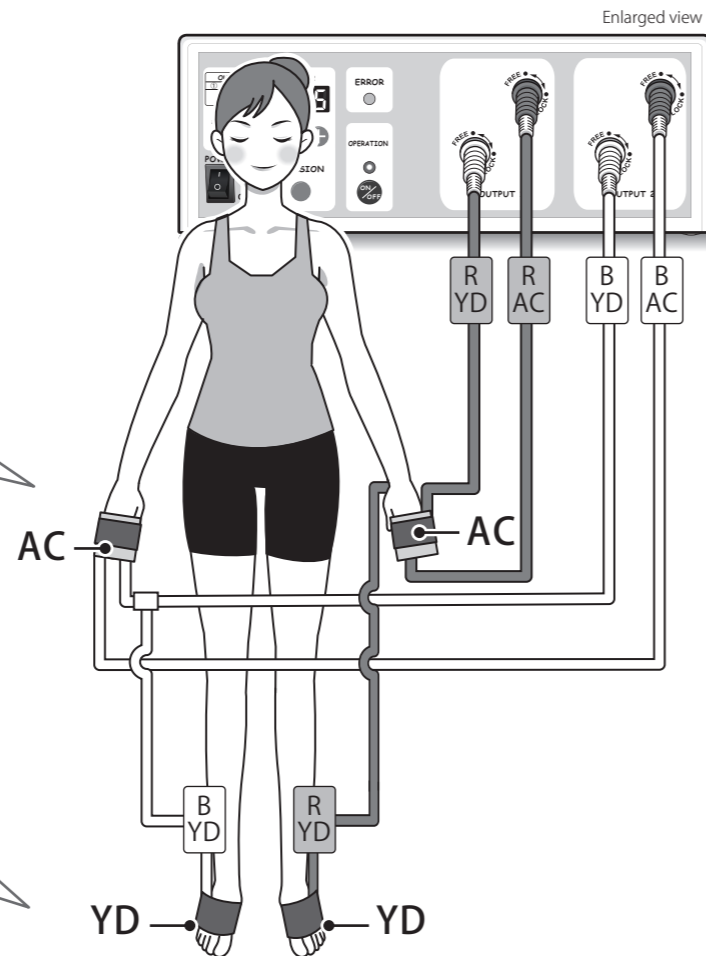
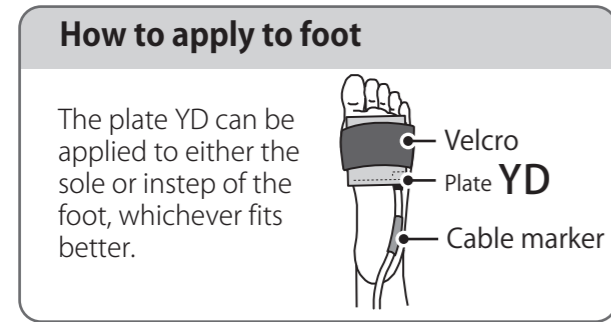
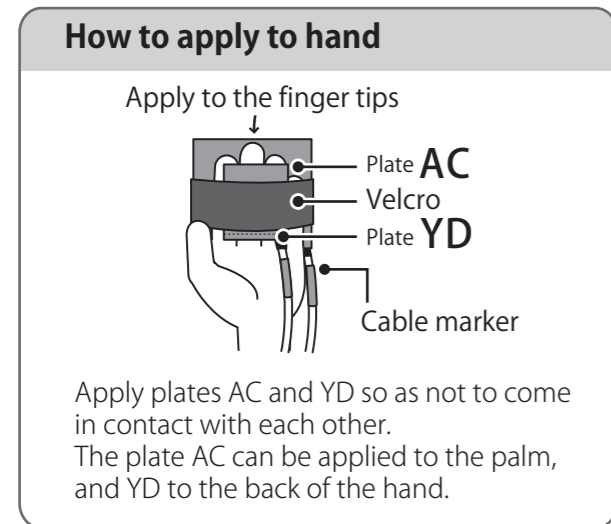
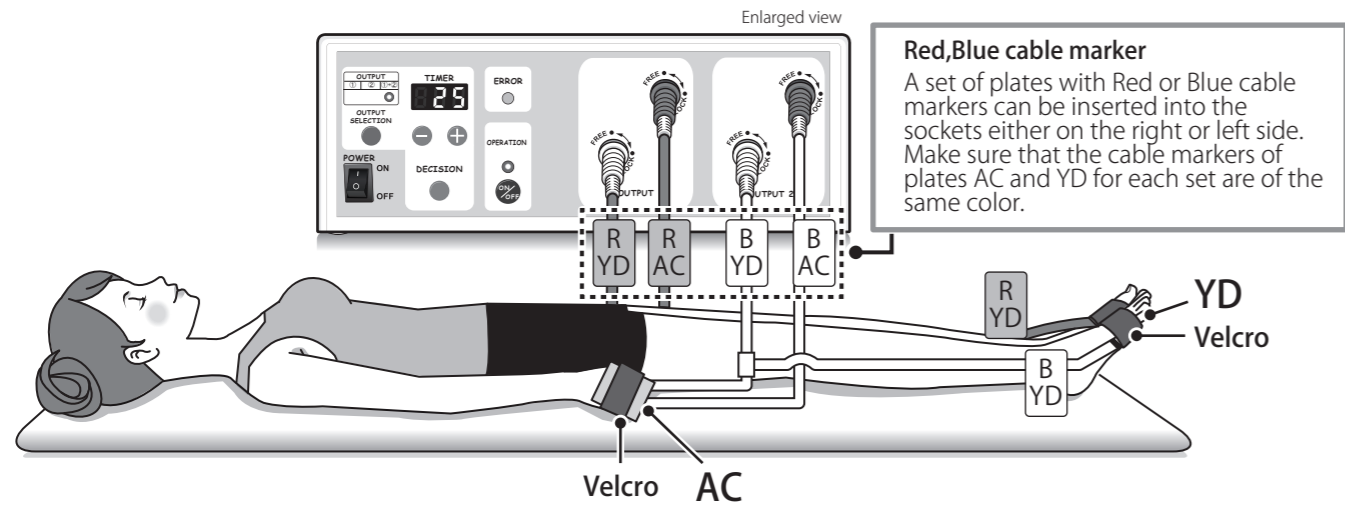

- Be sure to lie down while using the device.
 - The plates can be applied to either the right or left hand, however, make sure the cable markers of the plates applied to the hand and foot on each side must be of the same color.
 - Please make sure to have at least an hour between the end of the last session and the start of the next session.
- R AC R YD R AC→ Red cable marker AC
R YD R YD→ Red cable marker YD
B AC B YD B AC→ Blue cable marker AC
B YD B YD→ Blue cable marker YD

The illustrations above are for illustrative purposes and the shapes, color, etc. may be different from the real ones.

2. Hand and foot

OUTPUT 1 or OUTPUT 2

The plate AC on the back of the hand, YD on the palm, and YD on the sole of foot.

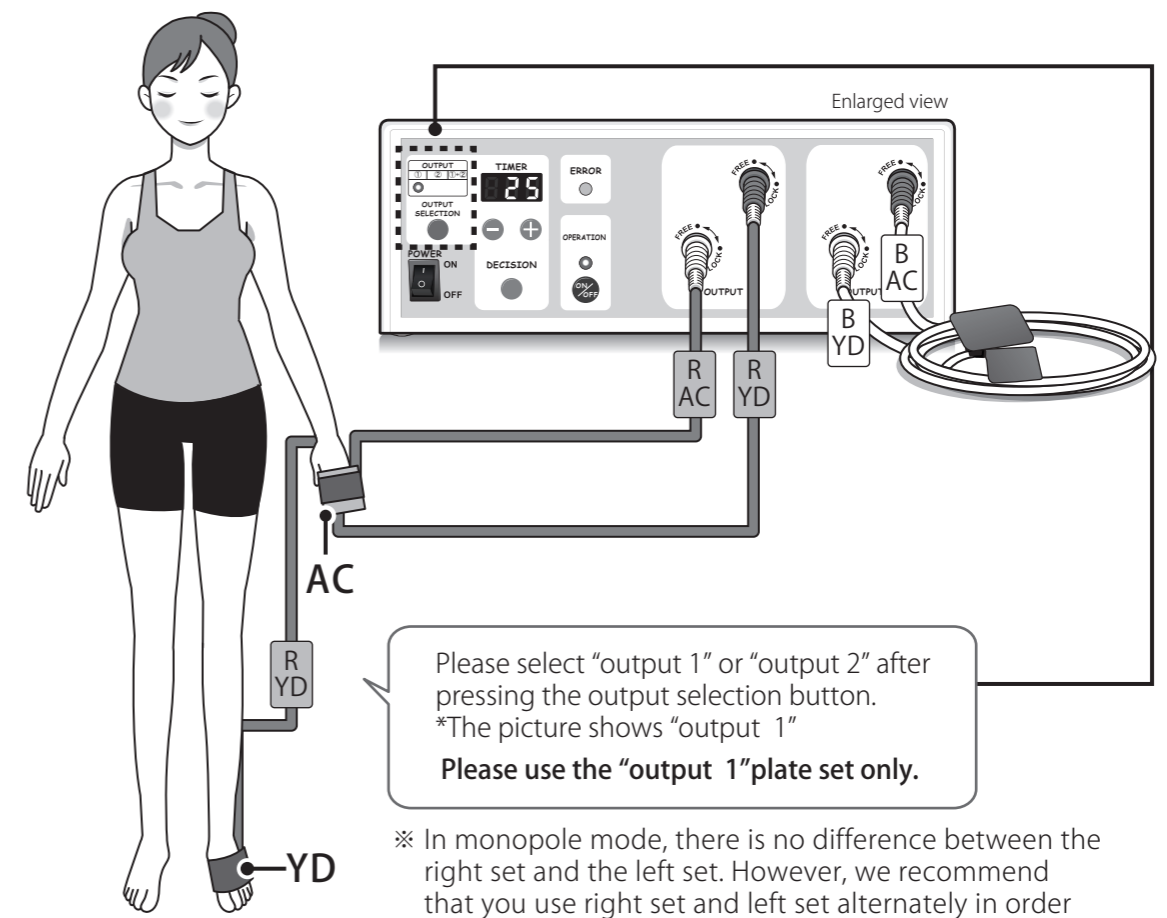
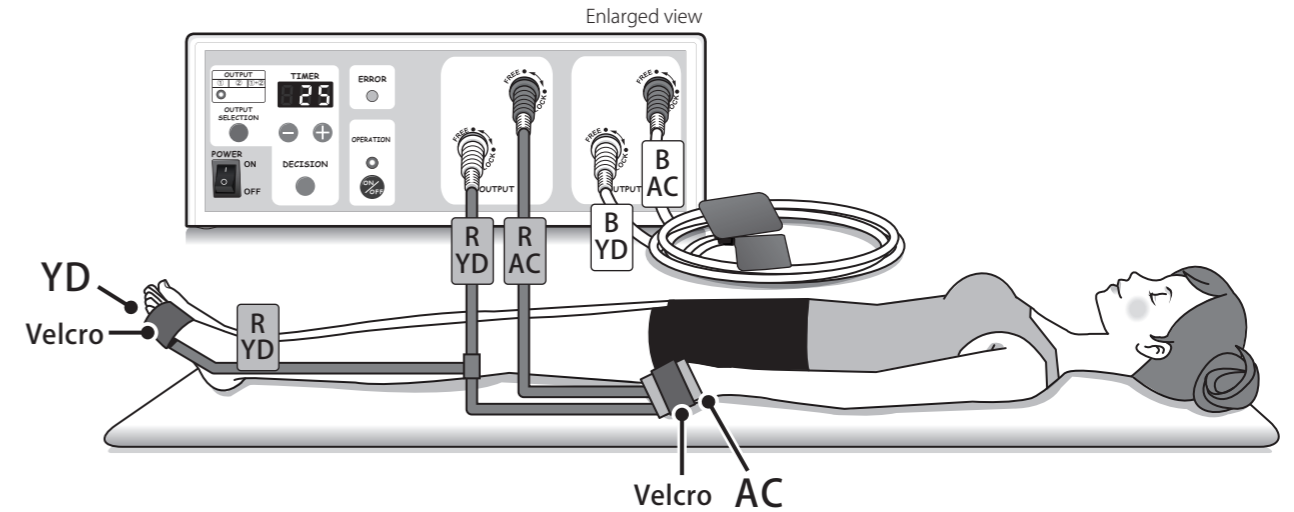

- Be sure to lie down while using the device.
 - The plates can be applied to either the right or left hand, however, make sure the cable markers of the plates applied to the hand and foot on each side must be of the same color.
 - Please make sure to have at least an hour between the end of the last session and the start of the next session.
- R AC R YD R AC→ Red cable marker AC
R YD R YD→ Red cable marker YD
B AC B YD B AC→ Blue cable marker AC
B YD B YD→ Blue cable marker YD

The illustrations above are for illustrative purposes and the shapes, color, etc. may be different from the real ones.

How to operate

[Initial setting] Set the end tone and operation tone volume

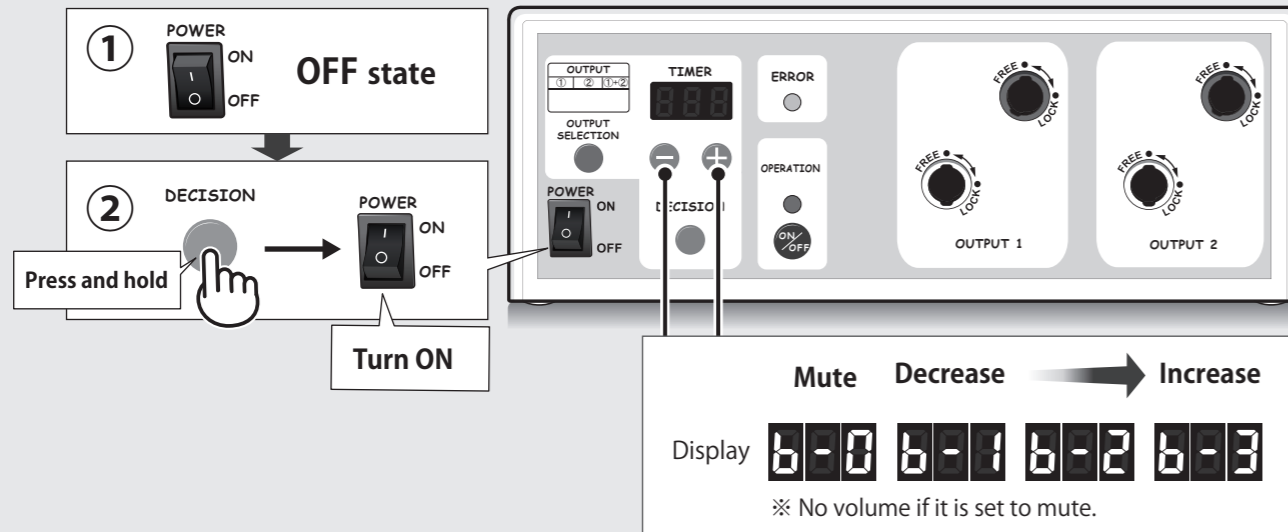

1 Turn On the Power Supply

Connect the plates and press the main power switch provided on the front of the main unit to turn it "ON". After all LEDs are lit and the display lights up "---", the in-memory output points and operating time are shown.

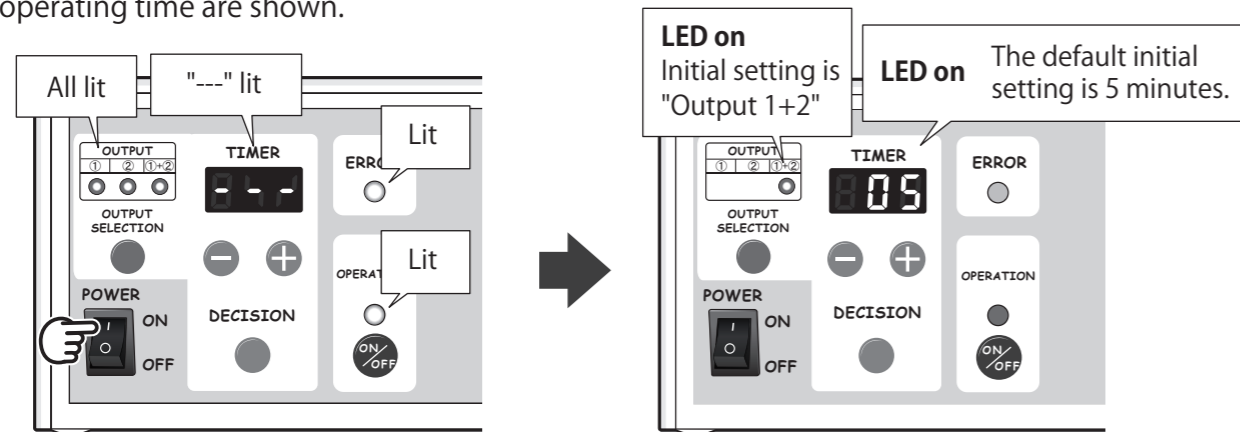

Caution Be careful that voltage gets unstable and this may erase the in-memory data if the power supply is fast switched between "ON" and "OFF" repetitively.

2 Selection of output position

Press the output selection button to select the number of output position.
Each time when you press the button, it will be switched in the order of "Output 1" → "Output 2" → "Output 1+2".
The LED at the selected output position will be on.

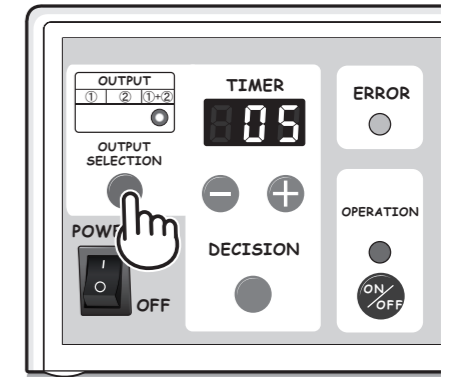
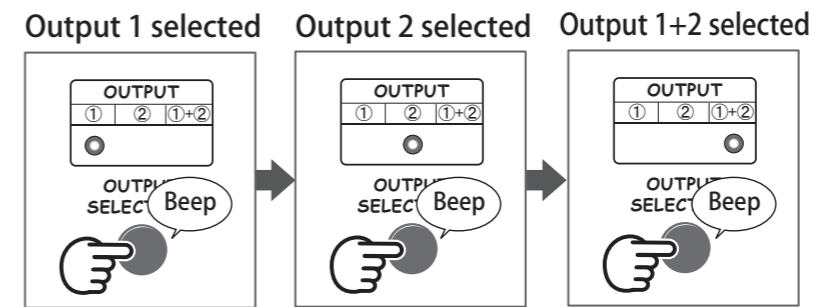

3 Set operating time

Press the + or - button to set the operating time.
The value can be set to 1-60 minutes.
It cannot be set to 0 minutes.
Press and hold the button to continuously increase or decrease the value.

The operating time is displayed on the timer display.

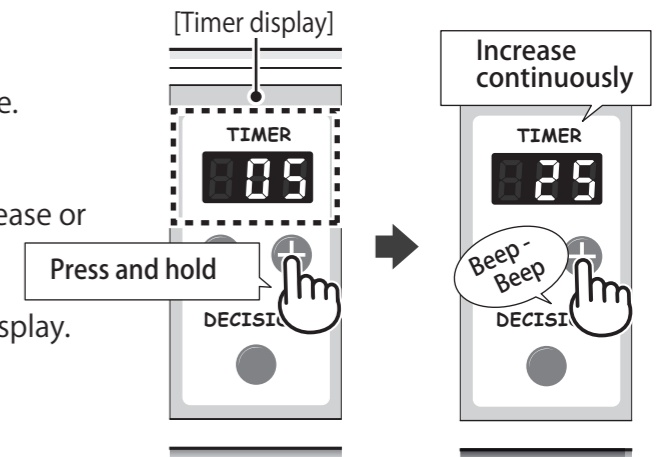

4 Memorize the configuration

Press the Decision button and memorize the configured output position and the operating time.



Notice It can run when you do not press the Decision button.
However, the configured output position and operating time will be not saved at the next operation.

[Example: Time is set to 25 minutes.]

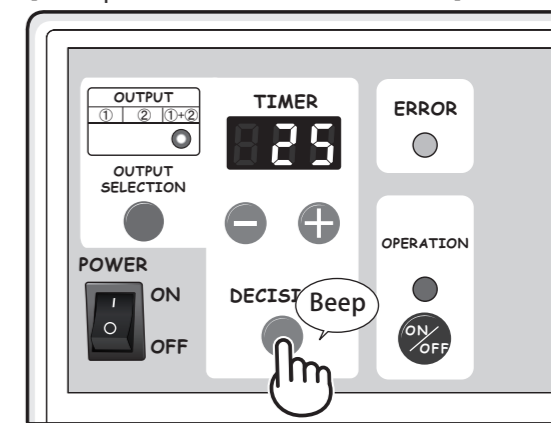

How to operate (Continued)

5 Start operation

Press the Operation button, and the LED above the button will be on and the device begins to work. The operating time displayed on the timer display will count down. When it is running, you can press the Operation button to stop the operation.

※ If you start operation based on the configured output position, operating time and buzzer volume, it will start operation when you just press the Operation button the next time.

※ To stop operation during operation

- Press the Operation button to stop the operation.

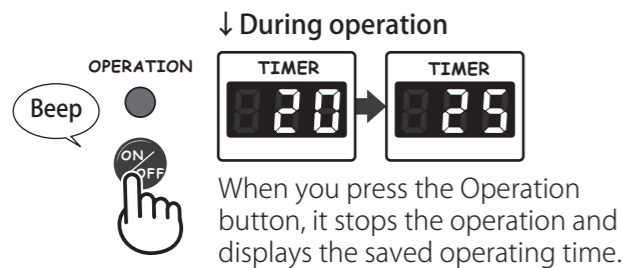

[Example: Time is set to 25 minutes.]

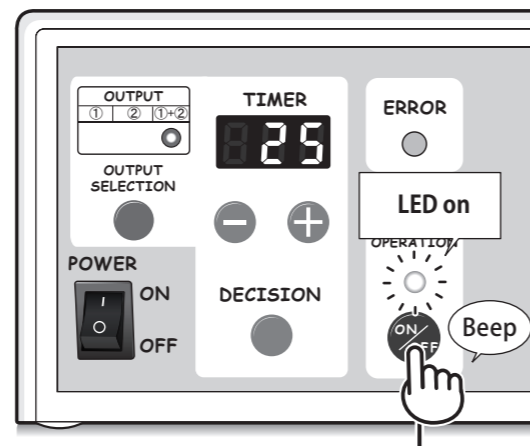

6 End a operation

At the end of the operation, it will buzz and stop running. The operating time initially set will be displayed.

The operating time is counted down



Upon completion, the display reverts to show the in-memory operating time.

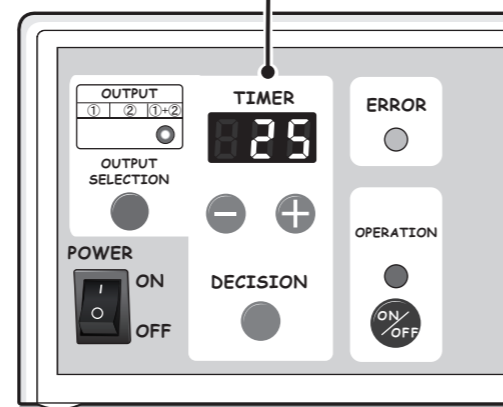
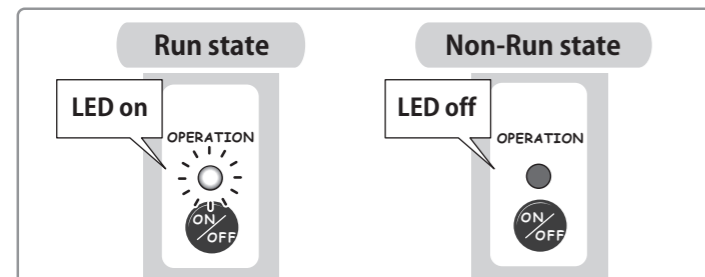

[Example: Time is set to 25 minutes.]

7 Turn off power

Please turn off the power switch on the front of the unit after use.

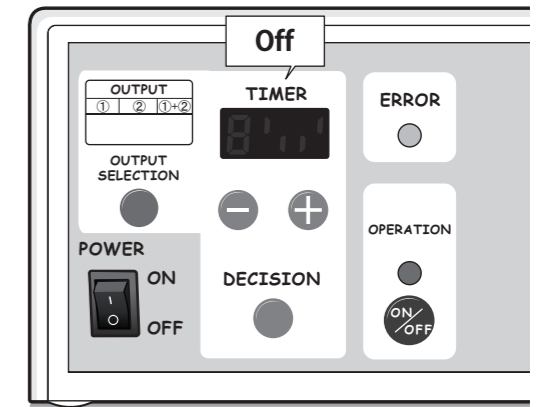

Remove the plates AC and BD or YD in reverse order.

Please make sure to remove the plug from the main unit, holding down the main unit so that it will not slip out of place.

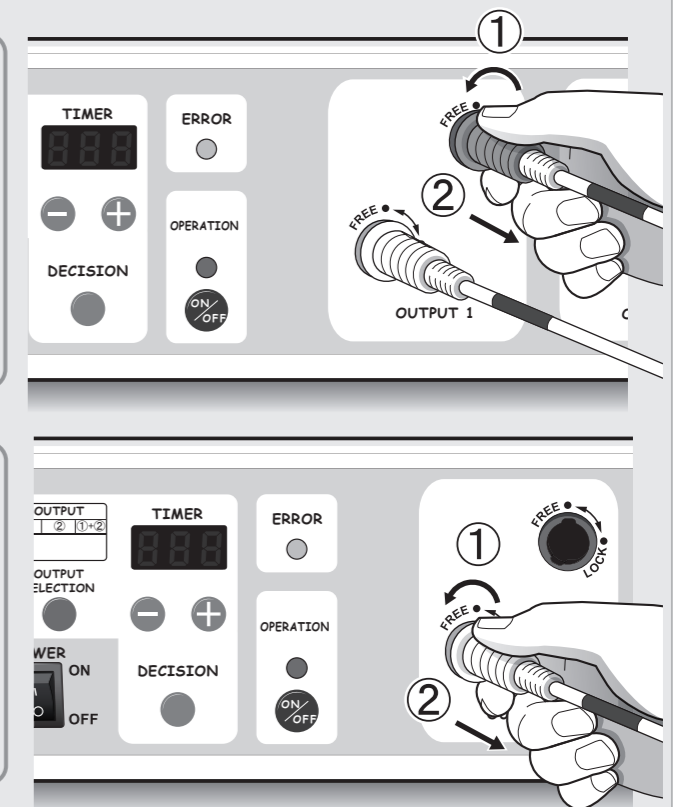
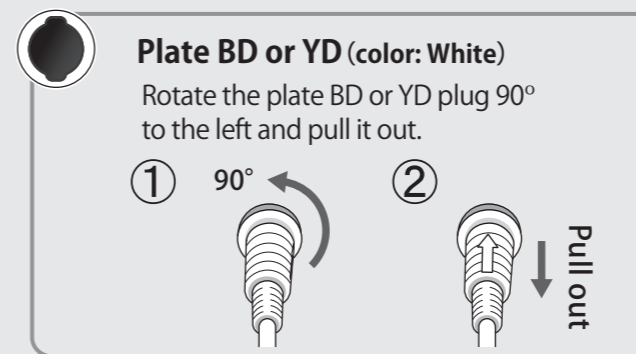
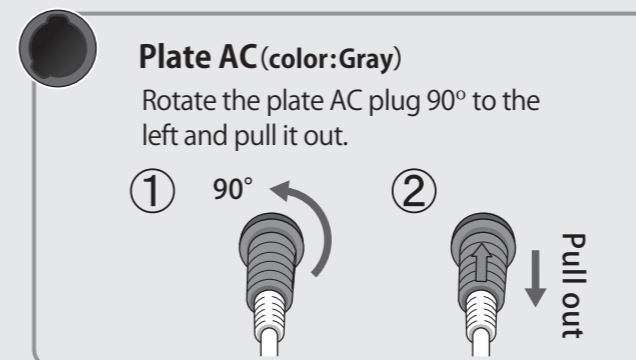

How to operate (Continued)

Fault display

If it runs when the plate is not properly connected or when the plug is disconnected during operation, it will stop running and start to buzz continuously, and the pink LED indicating poor connection will flash.

An error code is displayed on the display screen.

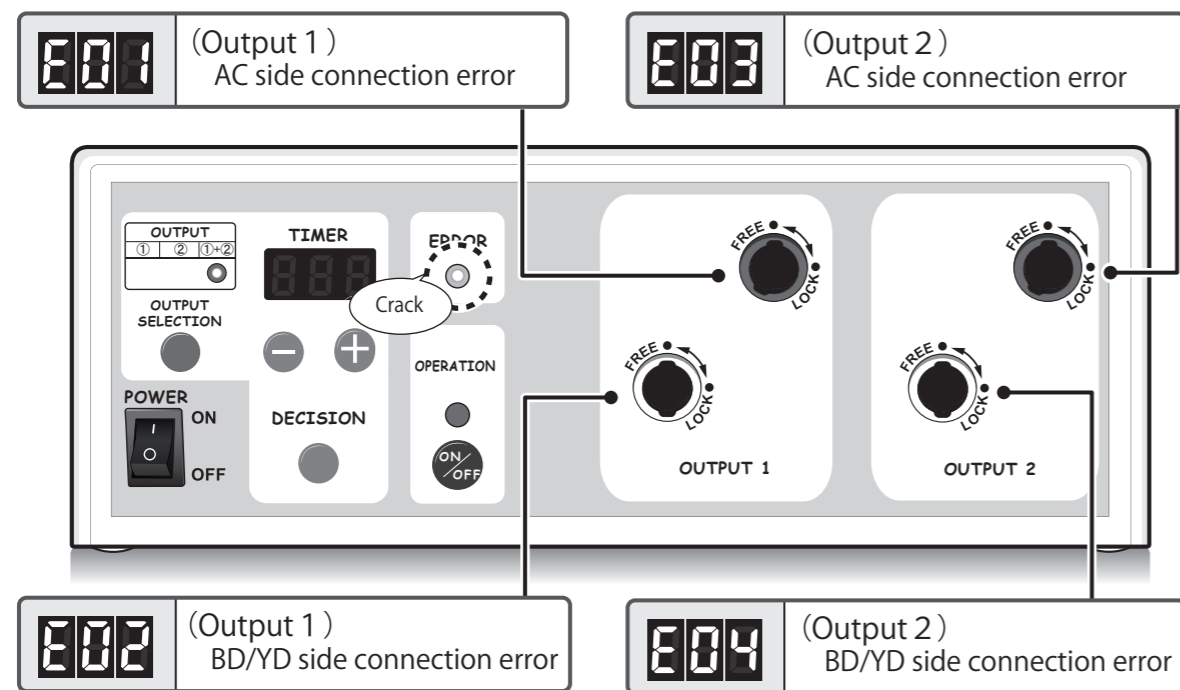

Please insert the plate properly.

Please identify the position of poor connection based on the error code and insert the plug properly. When multiple points have an insertion error, clearing the error that corresponds to the currently shown error code lets the system show the error code for other point of erroneous insertion. When the error is rectified, the poor connection LED will turn off and the error will be cleared. If an error occurs during operation, and you press the Operation button again, it starts from the time when the operation is stopped.

Example: For Output 1

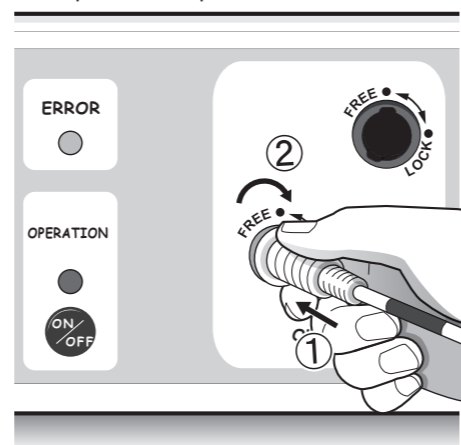

1. Intended use

ENERGY CHECK is a testing device intended to be used before using HD21

ENERGY CHECK is intended to check conductivity of the plate cables and output from the main body. It is not intended to check the degree of consumption or deterioration of the plates. Loudness of the sound emit from the plates cannot be used as a criterion for output check as it varies depending on the environment, etc.

2. How to use ENERGY CHECK

- 1 Place the ENERGY CHECK on a level surface and insert the uncovered plates AC, BD or YD into their respective slots as far as possible. Be sure to perform a check on each set of output1 and output2 plates.

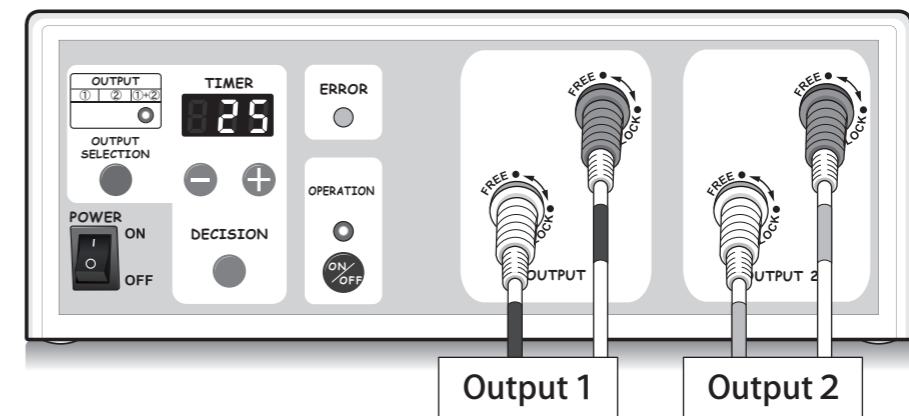

○ Correct setup

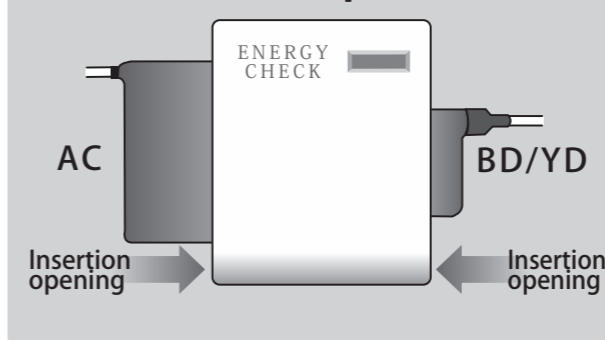

✗ Incorrect setup

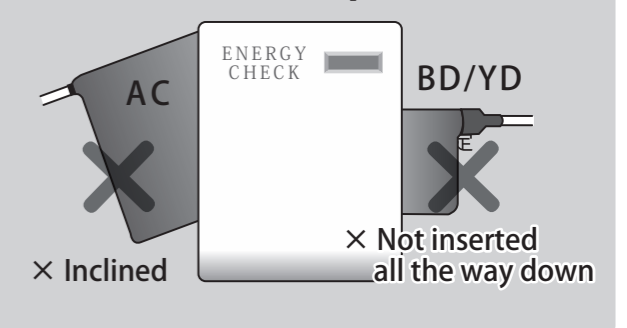

- 2 Check that there is no sign on the display after the plates are inserted all the way down.

When the plate is charged, the display may light up before the operating state. In that case, wait until the display completely disappears before checking. Also, if you check repeatedly, OK may not be displayed. Please check after a while.

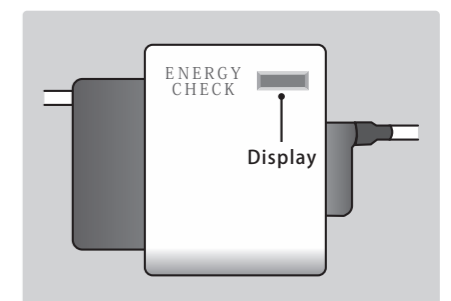

ENERGY CHECK

2. How to use ENERGY CHECK (Continued)

3 Turn on HD21. “OK” sign appears if there is no abnormality.

Be sure not to touch the plates AC and BD or YD while checking.

[Example: Time is set to 25 minutes.]

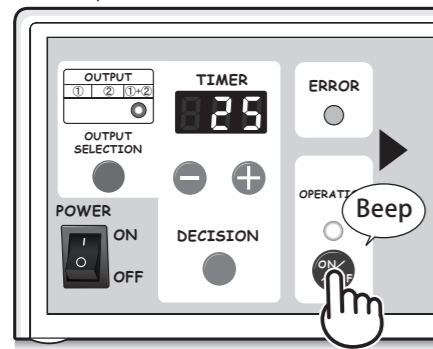

- → There is no problem if the sign appears even just for a moment.
- × → No response
Contact your dealer.
- × → A blurry sign
Go back to the first step and check again.

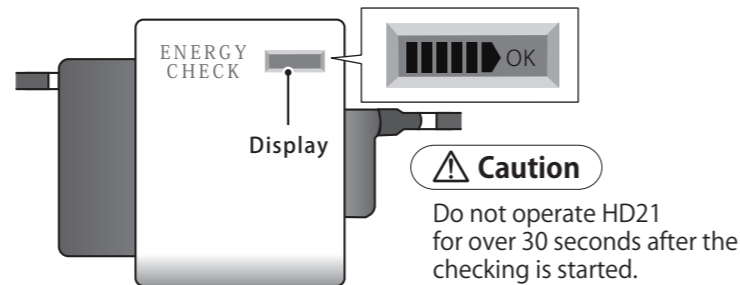

4 Touch the operation key and stop operation. Pull out the plates AC and BD or YD from the insertion openings.

If “OK” sign does not appear on the display of ENERGY CHECK, discontinue use and contact your dealer.

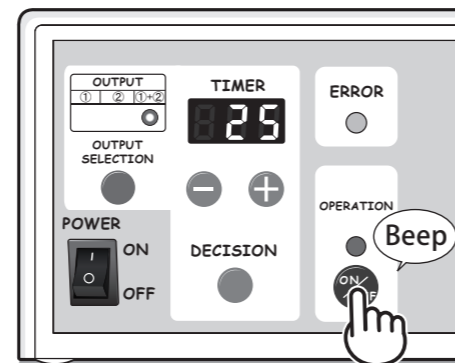

(Screen during operation)

3. Pay attention to the following instructions

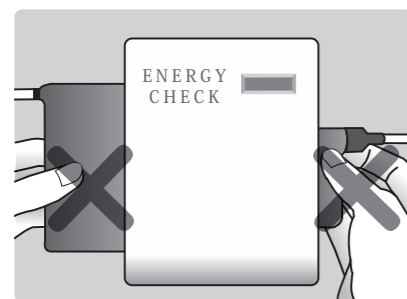

× Do not touch the plates with hands

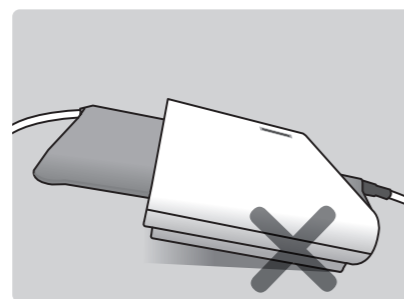

× Do not put ENERGY CHECK on an unstable surface

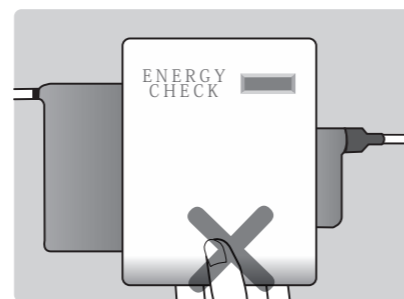

- Caution**
- Keep it away from infants and children.
 - Do not use it in a place where it may be exposed to water, such as in a bathroom.
 - Do not drop it from a high place or give it a strong shock.

- Do not modify or disassemble.
 - Do not use it for other than intended use.
 - Do not put it in a hot and humid place, or in a place where it is exposed to direct sunlight.
- ※ENERGY CHECK is not covered by warranty.

Troubleshooting

If you think something is wrong

Fault	Check	Measures
The unit is not energized after the power switch is turned on. The display screen area is off.	Is the power cord and the AC adapter connected correctly?	Insert the plug of the AC adapter into the special socket on the back of the unit.
		Insert the power cord's connector into the AC adapter's socket.
		Plug the power cord into the socket (100-240VAC).
An error is displayed.	Is the plug of the plate properly connected to the socket?	Insert the plug of the plate into the special socket. (P10)
The operation tone does not sound when the button is pressed.	Is “b-0” not set up for the buzzer volume?	Set the buzzer volume between “b-1” and “b-3”. (P16)
The end tone does not sound at the end of operation.	Is “b-0” not set up for the buzzer volume?	Set the buzzer volume between “b-1” and “b-3”. (P16)
“OK” message does not appear when checking the plates with ENERGYCHECK.	Do your hands come in contact with the plates?	Keep your hands off the cplates after the plates are inserted into ENERGY CHECK.
	Didn't you overlook the message as it is displayed only for a moment?	Check it again. There is no problem if the message appears even for a moment.
	Is the HD21 operating?	If not, touch the operation button.
	Is ENERGY CHECK put on a flat surface? Are the plates inserted into the insertion openings horizontally?	Put ENERGY CHECK on a flat surface and insert the plates into the insertion openings properly. Then check again.
	Did you check many times in a row?	Check again after a short while.

※ If the situation does not improve after taking countermeasures, the main body is malfunctioning. Ask your dealer for repair.

Other questions

Question	Answer
No or low sound from the plates.	The sound coming from a plate is a discharge sound generated when electrons pass through inside space of the plate. It varies depending on various reasons such as the usage environment and deterioration of the plate. The loudness of the sound cannot be used as a criterion for output as it varies depending on the environment.
Displaying time of the message on the display of ENERGY CHECK is short.	The display of ENERGY CHECK works by making it electrically charged, however, displaying time varies depending on a number of factors just like the sound mentioned above. The display is designed to discharge forcibly because it may be broken down if it is electrically charged for a long period of time. For the reason, the display does not show the sign throughout check. The criterion for output check is not loudness of the sound coming from a plate or displaying time of ENERGY CHECK, but whether ENERGY CHECK is responding to the plates or not.

Specifications

*Please note that the product specifications and appearance may be subject to change for reasons such as improvement, etc. without prior notice.

Brand name	HD 21
Model	HD 21
External dimensions	300(W) × 110(H) × 280(D)(mm)
Mains voltage	100-240V~
Rated frequency	50-60 Hz
Rated consumption	2 W
Weight	Approx. 2.2kg (main body)
Operation time	Manual setting (1 to 60 minutes)
Output voltage	DC-5000V ± 1000V
Safety features	<ul style="list-style-type: none"> •The device automatically stops when a plate plug is disconnected. •The device automatically stops when a plate plug is not properly inserted. •The device automatically stops when the main body is installed improperly.
Operating mode	Continuous operation

Accessories	Type YD	Type BD
Plate AC (2.5m/4m)	2pcs	2pcs
Plate YD (2.5m/4m)	2pcs	—
Plate BD (2.5m/4m)	—	2pcs
Cover for plate AC	4pcs	4pcs
Cover for plate YD/BD	8pcs	4pcs
Velcro XS (30-cm length)	4pcs	2pcs
Velcro M (80-cm length)	1pc	1pc
Velcro L (120-cm length)	1pc	1pc
AC adapter (1.25m)	1pc	1pc
Power cord (2m)	1pc	1pc
Instruction manual	1copy	1copy
ENERGY CHECK	1pc	1pc
Spiral tube (2.5m/4m)	10pcs/16pcs	10pcs/16pcs

Other information

How to store the device

- Keep the body unit and accessories clean, wash covers, etc. and then store them in a dry place in order so that they work properly when used next time.

Storage Precautions

Caution

-  When you use the device after a long period of storage, contact your dealer and have it inspected.
- Please keep the product away from dust and insects.
- Please remove dust between outlet and power cord plug.

-  Do not store in the following places.
 - Please keep the product away from fire or heat source.
 - Do not store the products in precarious places.
 - Do not expose the product to direct sunlight.
 - Please keep the product out of reach of child.

How to dispose of or transfer the device

- If you wish to dispose of or transfer the device, contact your dealer for safety and legal reasons.

Other information

Replacement of consumables (Not covered by warranty)



- The plate is consumable.
- To maintain full performance, it is recommended that plate AC be replaced every year.
- If you use a broken or damaged plate BD or YD, you may receive an electric shock, so we recommend that you inspect the plate BD every 1 to 2 years.
- When the power cord, AC adapter or any of the plates is damaged, discontinue use as it is dangerous to use it continuously. Replace damaged one with new one.
- A plate which has been used for many years may cause burns, electric shock or fire due to cable breakage, etc.

Maintenance list

Please maintain your device in accordance with the following table for proper and safe use. If you find any abnormalities, discontinue use and unplug the power cord. Then contact your dealer.

	Check items	What to check	Solution
Monthly Check	Cleaning of body unit	• The exterior must not have cracking, breakage, etc.	Contact your dealer if your device has any of the symptoms shown in the left.
	Power cord AC adapter	• Is the power cord and the AC adapter broken? • Is there a cut in the power cord and the AC adapter?	Contact your dealer if your device has any of the symptoms shown in the left.
		• Is there dust between the outlet and the power cord plug?	Unplug the power cord and remove dust.
Weekly Check	Plates	• The plates are not wet or damp, and are completely dry.	Remove the velcro after operation, and let the velcro and plates dry naturally, placing them apart.
		• Is there any breakage, cut, or deformation in the plates (applied parts) and the plate cables? • Do you feel a shock similar to an electric shock during operation?	Contact your dealer if your device has any of the symptoms shown in the left.
Daily Check	Covers and velcro	• Are the covers and velcro kept clean?	Wash them frequently as ingredients such as sweat, etc. stick to them.
	Check with ENERGY CHECK	 Refer to page 21 and 22	Contact your dealer if the "OK" sign does not appear on the display of ENERGY CHECK.

Cautions for care

-  Wipe with a dried soft cloth and never use benzine or thinner for cleaning.
- Before cleaning, hold the power cord plug and disconnect it from the outlet as it may cause electric shock.
-  When removing cords, do not apply excessive force to the connections, such as by holding the cord and pulling it out.
- Wet or damp plates must be dried naturally. Do not dry them with a hair dryer or a heater.

